

Hydraulic Adapter Sleeves 紧定套

H3900,H3000,H3100,H3200,OH3000,OH3100,OH3000,OH3900 Series

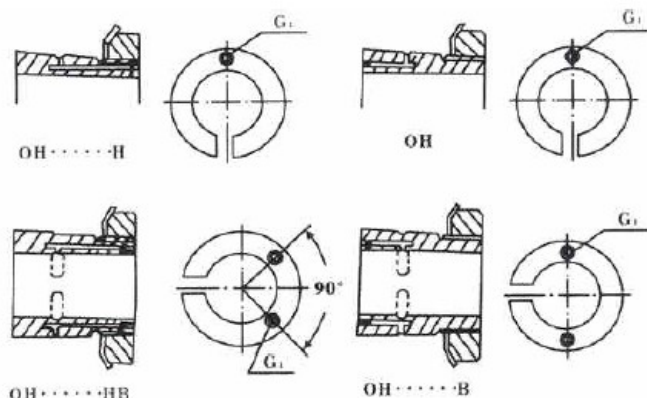

Bore Size=670 to 710mm

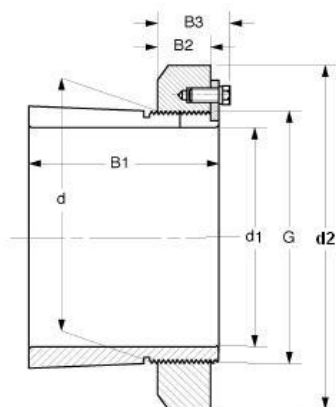

MVB	Dimensions (mm)								Weight	Appertaining Device	
Item No.	d1	d	d2	B1	B2	B3	G	G ₁	(kg)	Lock Nut	Lock Washer
H30/710	670	710	830	342	90	112	Tr710×7	-	228	HML/710	MSL/710
OH30/710	670	710	830	342	90	112	Tr710×7	M8	228	HML/710	MSL/710
OH30/710H	670	710	830	342	90	112	Tr710×7	M8	228	HML/710	MSL/710
OH30/710B	670	710	830	342	90	112	Tr710×7	M8	228	HML/710	MSL/710
OH30/710HB	670	710	830	342	90	112	Tr710×7	M8	228	HML/710	MSL/710
H31/710	670	710	900	467	106	135	Tr710×7	-	392	HM/710	MS/710
OH31/710	670	710	900	467	106	135	Tr710×7	M8	392	HM/710	MS/710
OH31/710H	670	710	900	467	106	135	Tr710×7	M8	392	HM/710	MS/710
OH31/710B	670	710	900	467	106	135	Tr710×7	M8	392	HM/710	MS/710
OH31/710HB	670	710	900	467	106	135	Tr710×7	M8	392	HM/710	MS/710
H32/710	670	710	900	572	106	135	Tr710×7	-	459	HM/710	MS/710
OH32/710	670	710	900	572	106	135	Tr710×7	M8	459	HM/710	MS/710
OH32/710H	670	710	900	572	106	135	Tr710×7	M8	459	HM/710	MS/710
OH32/710B	670	710	900	572	106	135	Tr710×7	M8	459	HM/710	MS/710
OH32/710HB	670	710	900	572	106	135	Tr710×7	M8	459	HM/710	MS/710
H39/750	710	750	870	291	90	112	Tr750×7	-	211	HML/750	MSL/750
OH39/750	710	750	870	291	90	112	Tr750×7	M8	211	HML/750	MSL/750
OH39/750H	710	750	870	291	90	112	Tr750×7	M8	211	HML/750	MSL/750
OH39/750B	710	750	870	291	90	112	Tr750×7	M8	211	HML/750	MSL/750
OH39/750HB	710	750	870	291	90	112	Tr750×7	M8	211	HML/750	MSL/750
H30/750	710	750	870	356	90	112	Tr750×7	-	246	HML/750	MSL/750
OH30/750	710	750	870	356	90	112	Tr750×7	M8	246	HML/750	MSL/750
OH30/750H	710	750	870	356	90	112	Tr750×7	M8	246	HML/750	MSL/750
OH30/750B	710	750	870	356	90	112	Tr750×7	M8	246	HML/750	MSL/750
OH30/750HB	710	750	870	356	90	112	Tr750×7	M8	246	HML/750	MSL/750
H31/750	710	750	950	496	112	141	Tr750×7	-	451	HM/750	MS/750
OH31/750	710	750	950	496	112	141	Tr750×7	M8	451	HM/750	MS/750
OH31/750H	710	750	950	496	112	141	Tr750×7	M8	451	HM/750	MS/750
OH31/750B	710	750	950	496	112	141	Tr750×7	M8	451	HM/750	MS/750
OH31/750HB	710	750	950	496	112	141	Tr750×7	M8	451	HM/750	MS/750